



STAINLESS STEEL
LAUNDRY ROOM DROP-IN SINK



*Shown With Faucet Hole Revision **K-472**

Item #: _____ Qty #: _____
 Model #: _____
 Project #: _____

FEATURES:

One piece seamless **Deep Drawn** stainless steel bowl.
 Sink bowl is sound deadened.
 Self rimming design.
 Three 4" O.C. holes. Use K-472 for additional
 Units feature Advance Tabco's **Smart Finish™**.
 Mounting clips provided accommodate all thicknesses of
 counter.

MATERIALS:

14 Gauge, 304 Stainless Steel.
 3 1/2" Stainless Steel basket drain with 1 1/2" IPS included.

DESIGN:

Units are punched with 1 1/4" diameter faucet holes.

OPTIONAL:

K-472 Faucet Hole Revision

Model#	Gauge	Bowl Size L x W x D	O.A. L x W	Cut-Out Size	Approx. Wt.
LS-2418-14RE	14	24" x 18" x 14"	27" x 23"	26 1/4" x 20 1/4"	42 lbs.

NOTE: Sink requires 30" wide countertop (front to back)

DIMENSIONS and SPECIFICATIONS

TOL ± .125"

ALL DIMENSIONS ARE TYPICAL

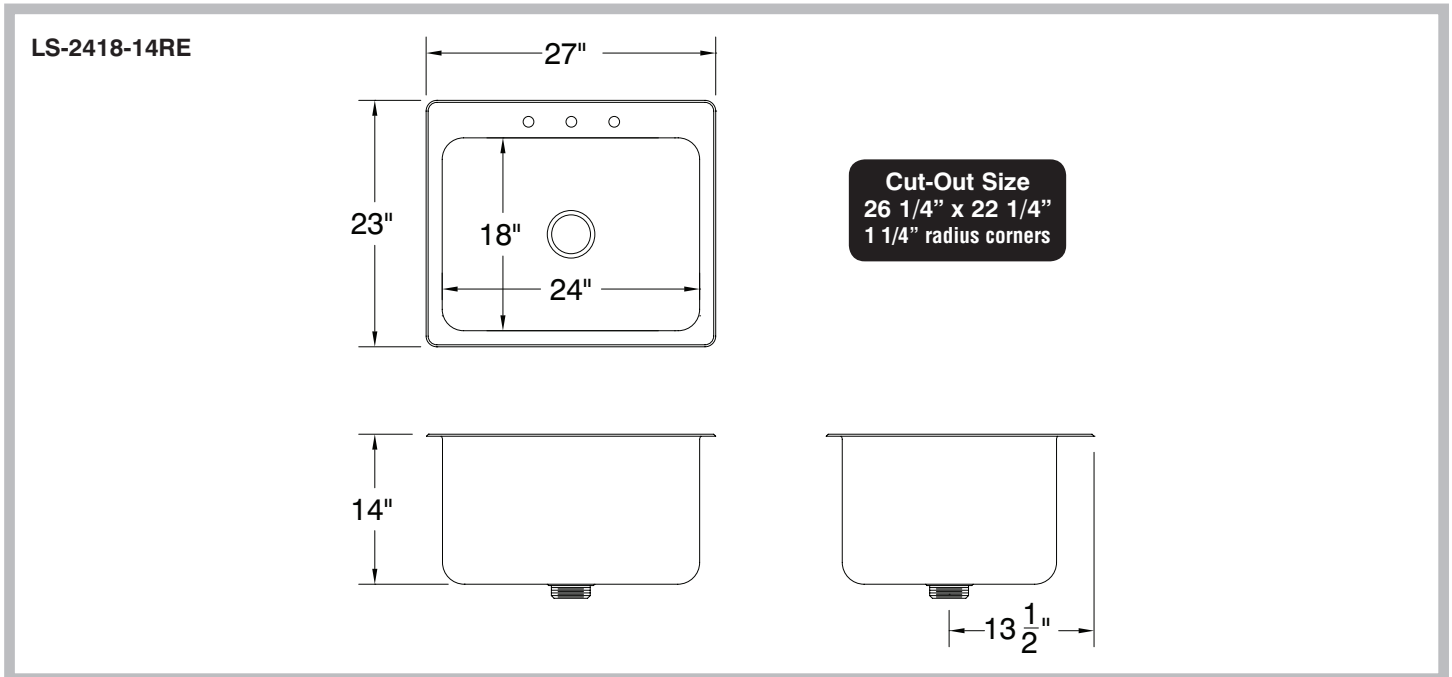

Customer Service Available To Assist You **1-800-645-3166** 8:30 am - 7:00 pm E.S.T.

For Orders & Customer Service:
 Email: customer@advancetabco.com or Fax: 631-242-6900

For Smart Fabrication™ Quotes:
 Email: smartfab@advancetabco.com or Fax: 631-586-2933